



赫兹电力

HERTZ POWER



HZFA-V

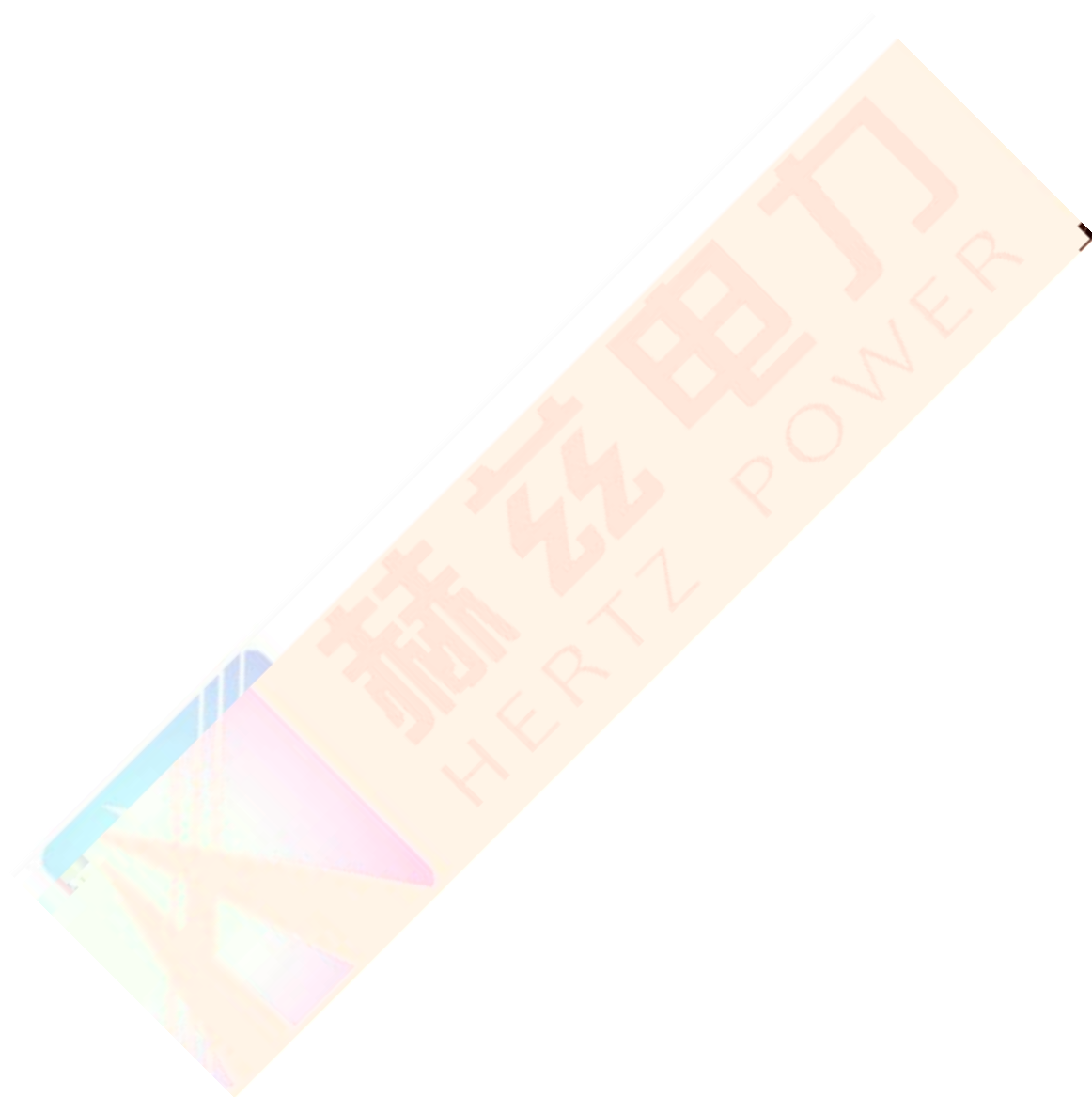

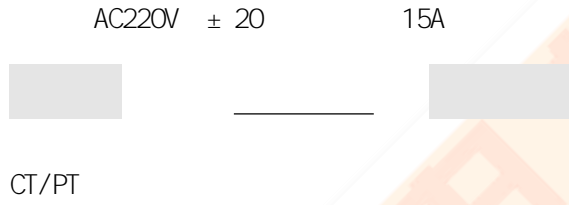

PT

CT

PT

/

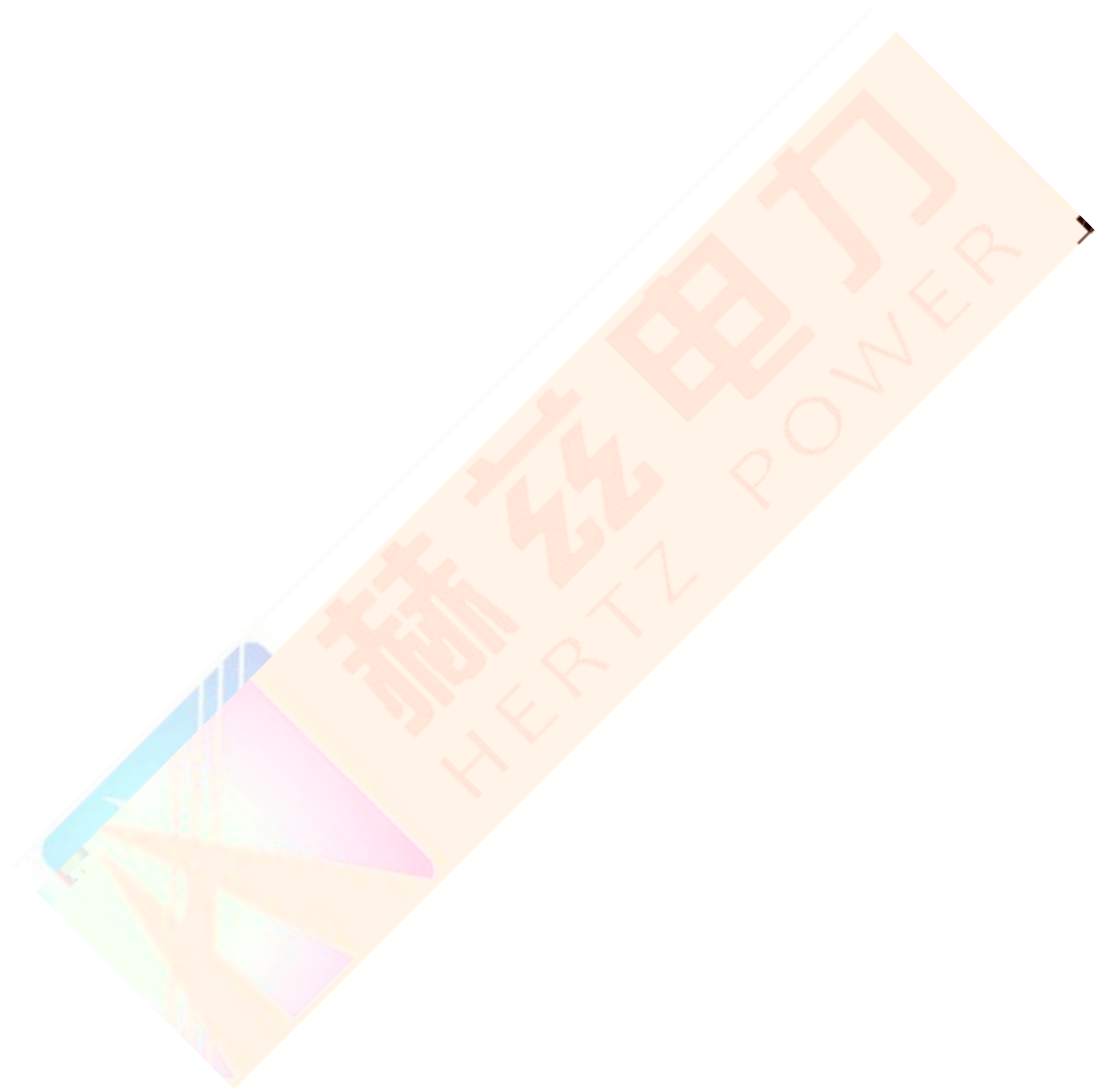

2000

/

RS232

U

20Kg

| | | | | | |
|----|------------------------------|---------|--------|-------------|--------|
| CT | 220V | 0—1000V | 20A | 3KVA | < 0.5% |
| PT | 220V | 0—330V | | 3KVA | < 0.5% |
| CT | 220V | 0-8V | 0—600A | | < 0.5% |
| PT | 220V | 0—1000V | | | < 0.5% |
| CT | 999.9K: 5/1 | | | | < 0.5% |
| PT | 999.9K: 100 150 100/3 100/ 3 | | | | < 0.5% |
| | 0-20 | | | | < 0.5% |
| | 0.01 | ± 5 | | 0.01% | <0.5% |
| | 0-200A | 5 | | 0-1000V | 5 |
| | -10 | 55 | | AC220V ± 20 | 50HZ |
| | 350x 240x 270 | | | 20Kg | |

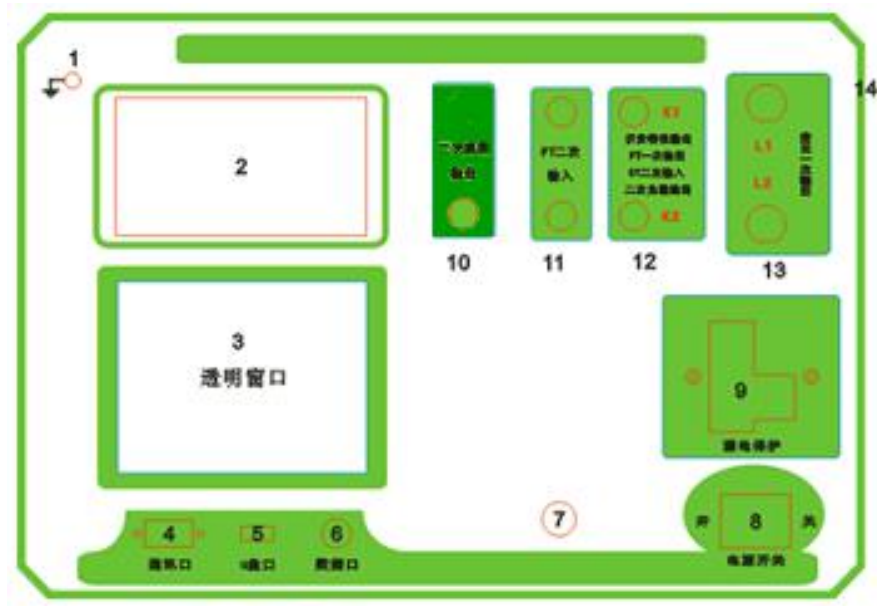

- | | | |
|-------|-------|-----------|
| 1 | 2 | 3 |
| 4 PC | 5 U | 6 |
| 7 | 8 | 9 + |
| 10 | 11 PT | |
| 12 / | /PT | / CT |
| 13 CT | 14. | 220V ± 10 |

1.

" " " " "

"

" "

2.

220V

CT PT U

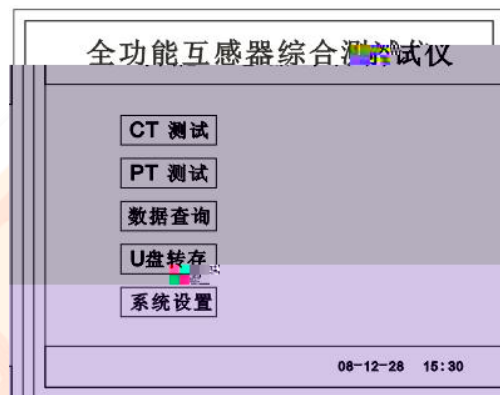

3. CT



CT 参数设置

编号: ABC001

相序: A

Kn: 1

变比: 1000:5

确定

CT

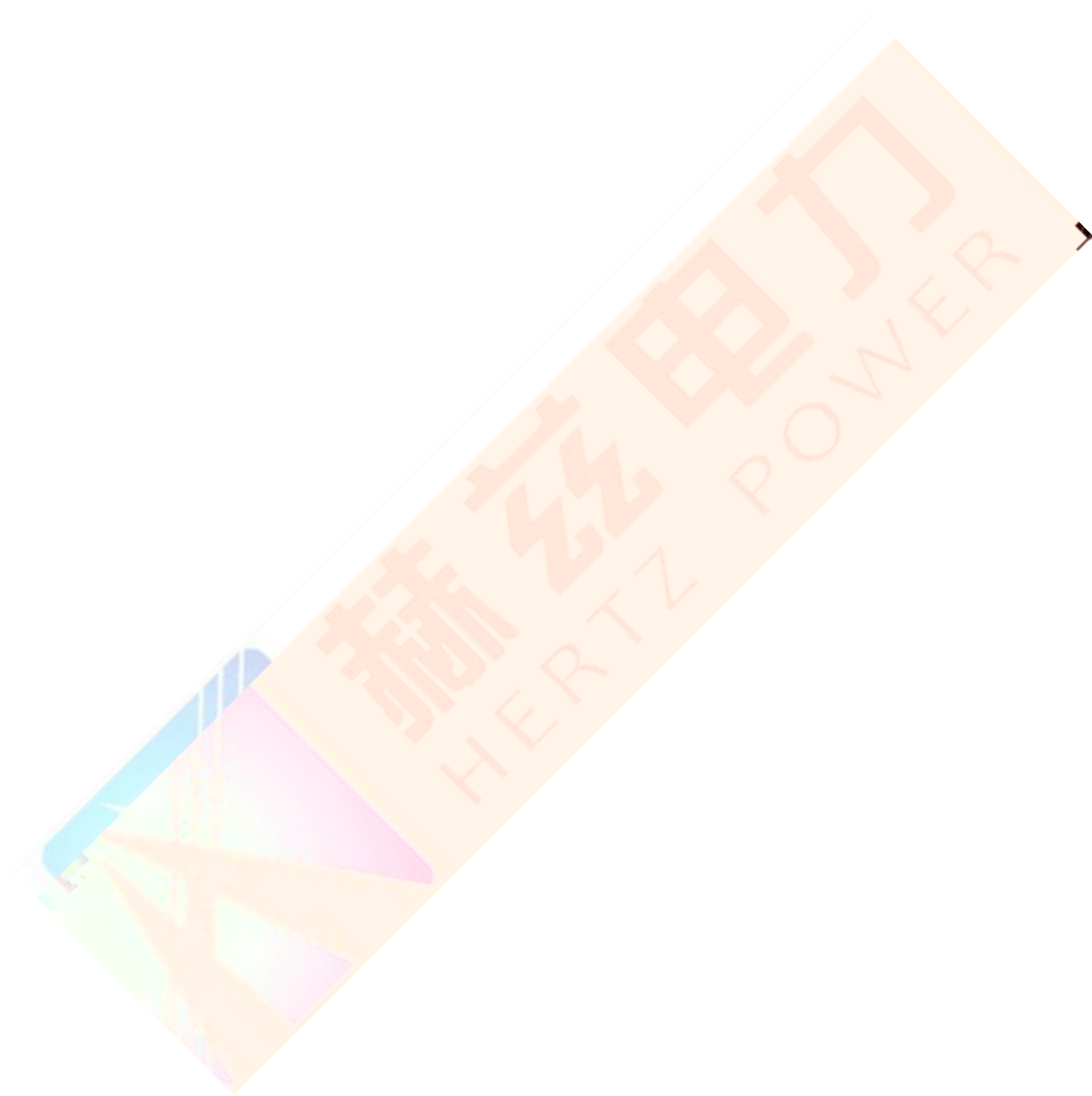

c.

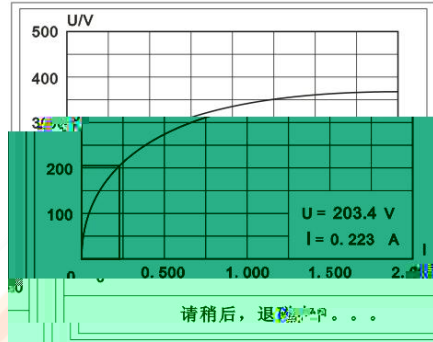
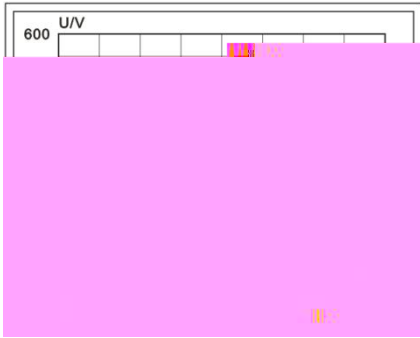
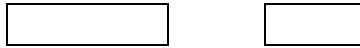

d.



()

e.

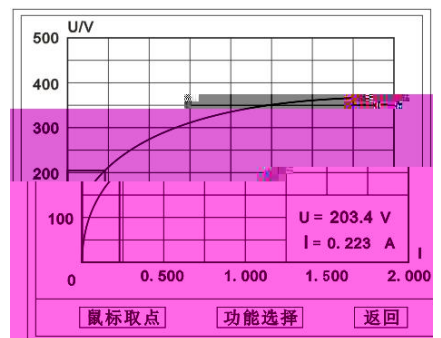

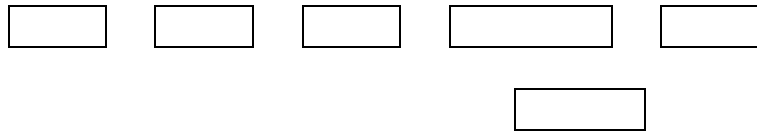

- ◆
- ◆
- ◆



- ◆

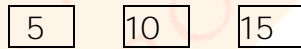

D. CT

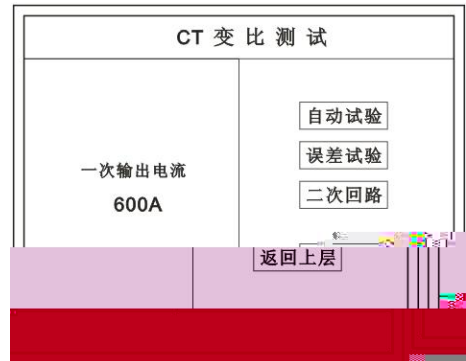
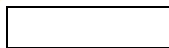

a.

- ◆
- ◆
- ◆
- ◆
- ◆

0 - 600 A

1 5 20 100 120

5 200A

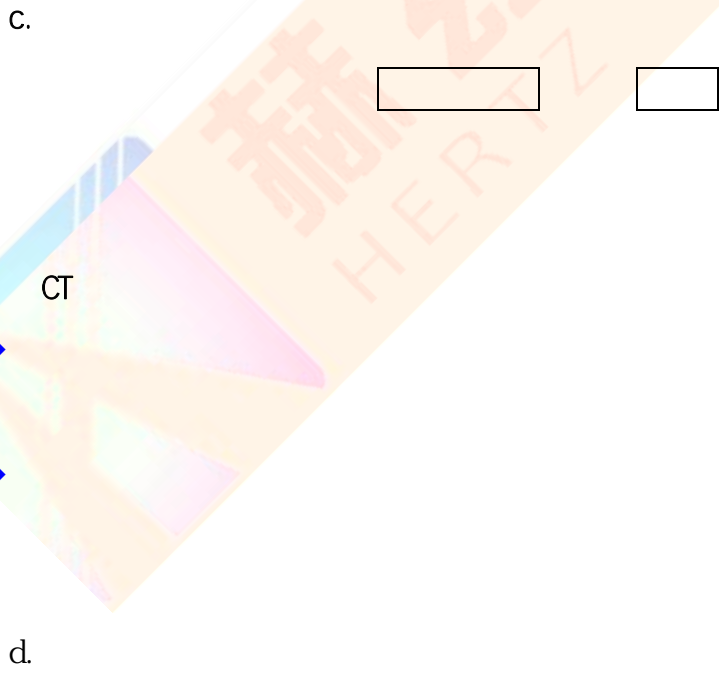
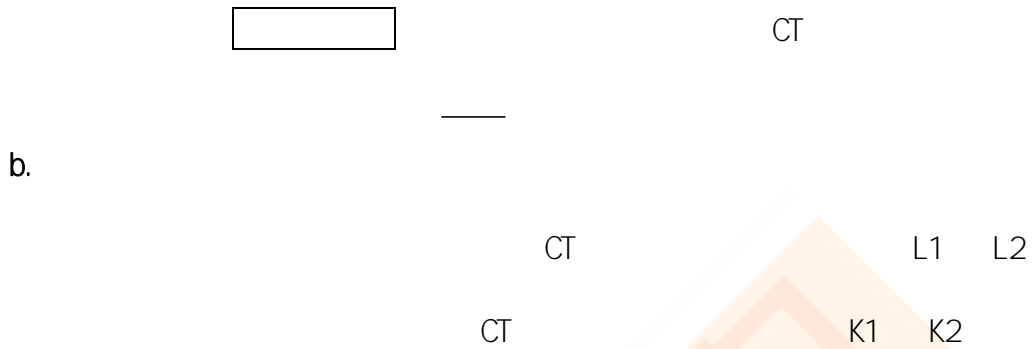

一次侧: 400.0 A

| | |
|-----|----------|
| 二次侧 | 0.400A |
| 比值 | 5.000K:5 |
| 角差 | 1.83' |
| 比差 | 0.00% |
| 极性 | 同相/- |

保存 打印 返回

CT 误差试验

| | 角差 | 比差 |
|------|-------|-------|
| 1% | 40.3' | 1.30% |
| 5% | 12.6' | 0.30% |
| 20% | 1.32' | 0.00% |
| 100% | 0.83' | 0.00% |
| 120% | 5.25' | 0.20% |

一次侧: 400.0 A 保存 打印 返回

e.

5

200A

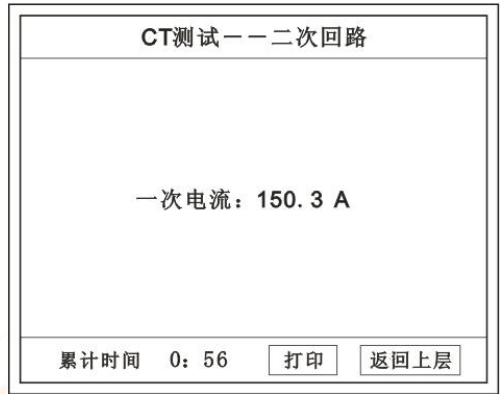

E.

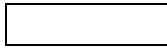

4. PT

PT

PT

PT

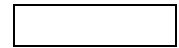
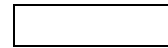

CT

CT

A. PT



PT

PT

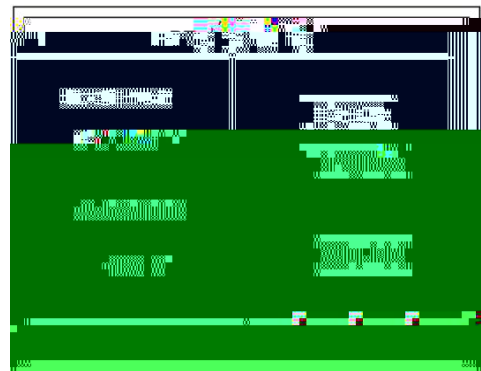
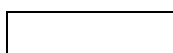

a.



0 - 3 A



0~330V



b.



B. PT

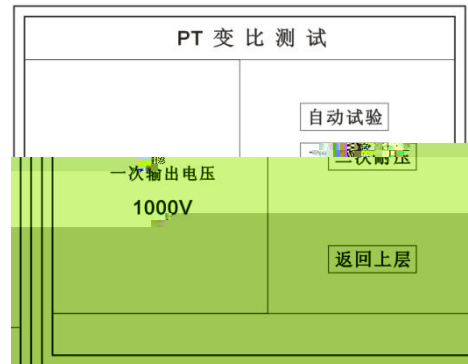
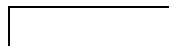
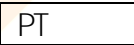

a.



0 - 1000



5

b.



PT

a x

c.

5

1000V

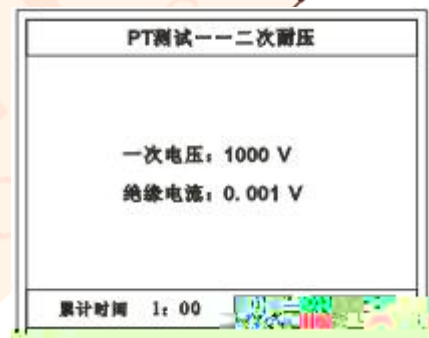

5.

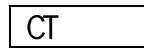

A. CT

a.



b.

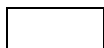
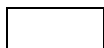
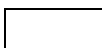

B. PT

CT

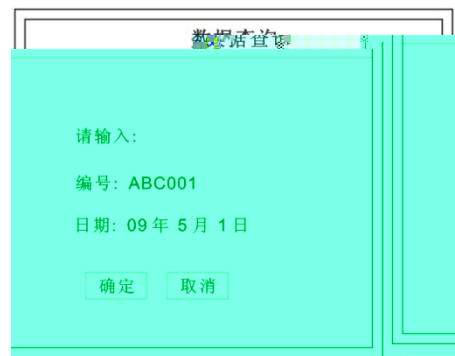

| N | 编号 | 相序 | Kn | 时间 | 类型 |
|---|--------|----|----|----------------|----|
| 1 | ABC001 | A | | 09-05-01-15:23 | 变比 |
| 2 | ABC001 | A | 1 | 09-05-01-15:23 | 变比 |
| 3 | ABC001 | A | 1 | 09-05-01-15:23 | 伏安 |
| 4 | ABC001 | A | 2 | 09-05-01-15:23 | 伏安 |



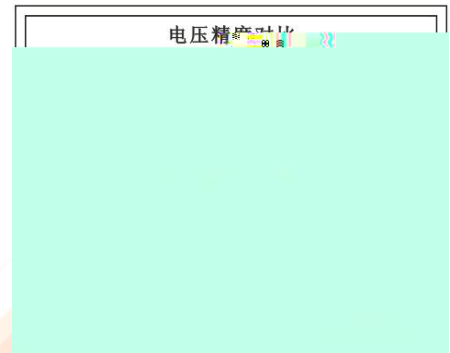

1.

CT

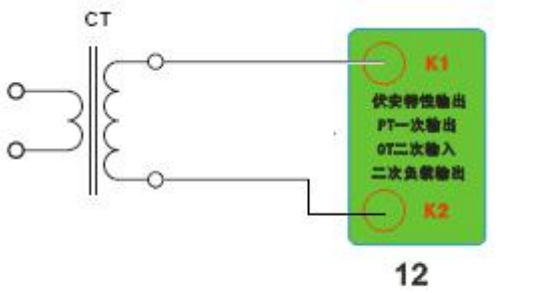

2.

CT

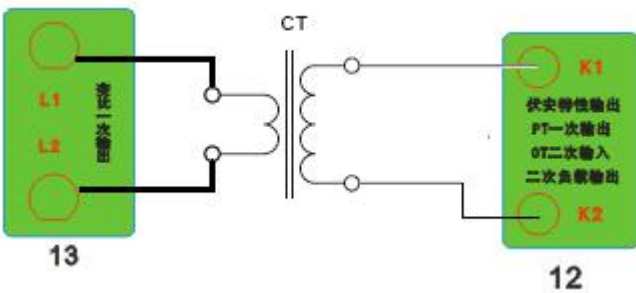

3

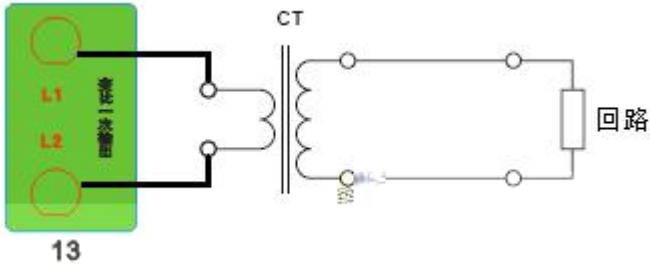

4

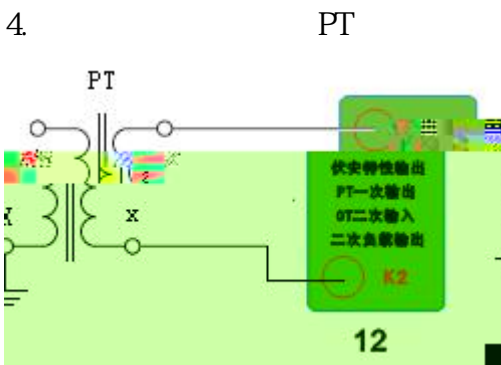

5

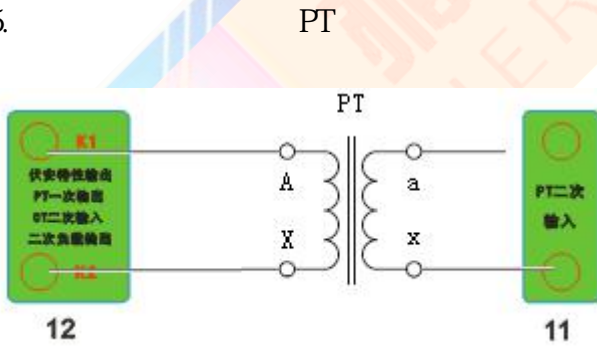

6

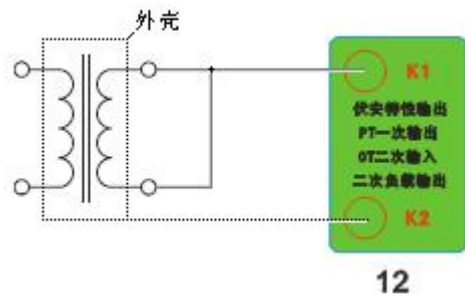

7.

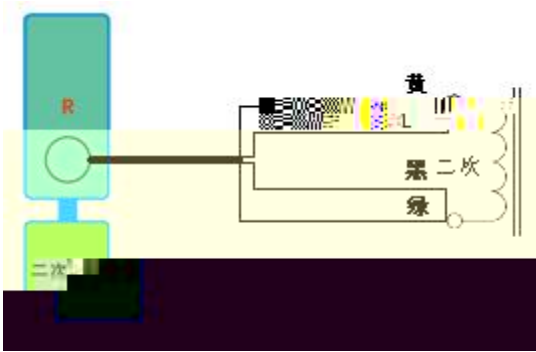

8.

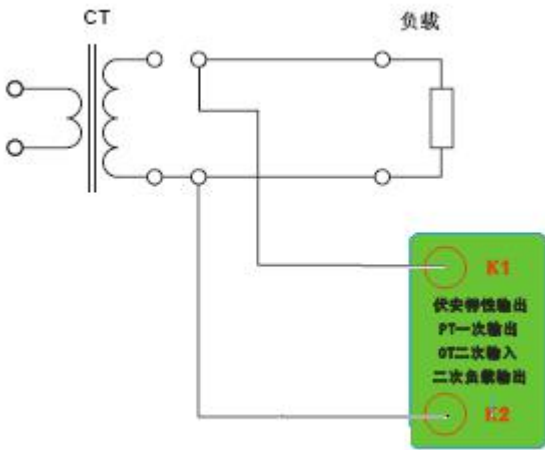

12

1

2

1.

2

1

2

3

2

24

027-83267669

24

48

4