

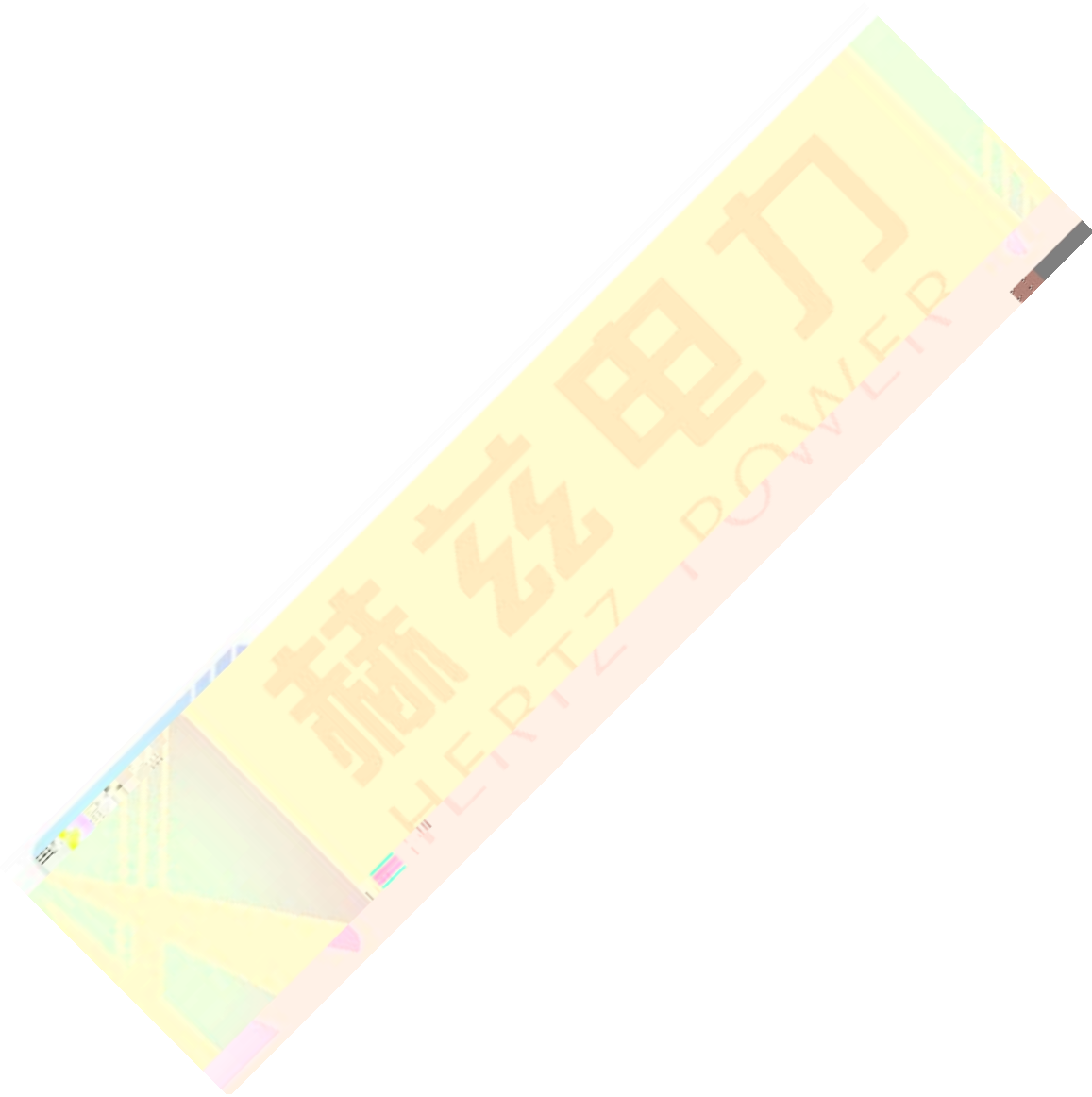

HZCS-111





W.



赫兹电力
HERTZ POWER

产品宗旨：技术领先，质量可靠，轻便易用
服务宗旨：快速响应，达到满意，超过期望





赫兹电力
HERTZ POWER

产品宗旨：技术领先，质量可靠，轻便易用
服务宗旨：快速响应，达到满意，超过期望



3KW



HZCS-111

()

45H 55Hz

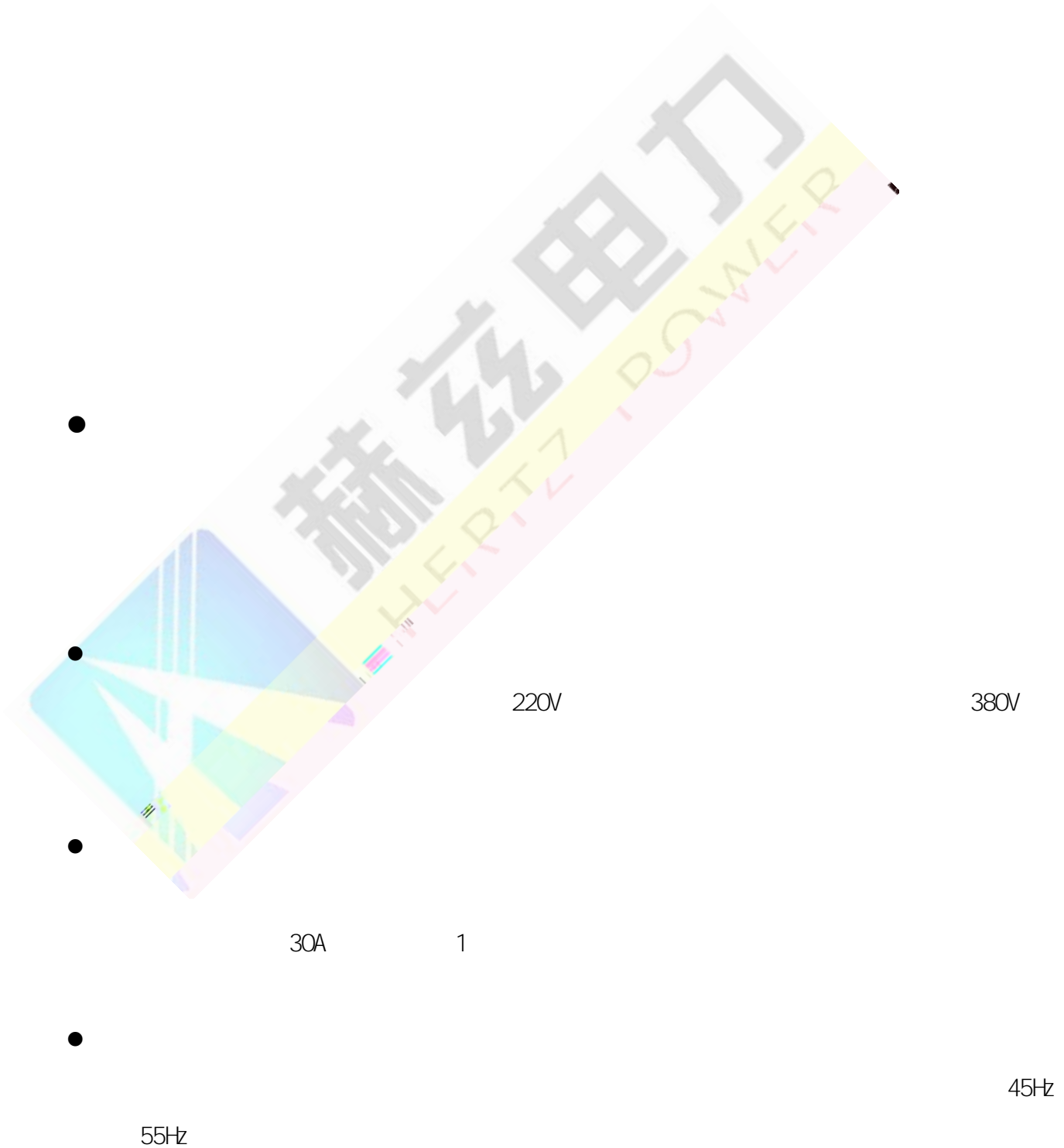

220V

380V

30A

1

45Hz

55Hz



赫兹电力
HERTZ POWER

产品宗旨 技术领先, 质量可靠, 轻便耐用
服务宗旨 快速响应, 客户满意, 超过期望

@

BDNg

-
-
-



C



			AC250V
			0.5%
4			0.5%
			8A
			45Hz 55Hz
			0.01 30μF
5			0.01 400
			-180° +180°
			0.0001μF
6			0.0001
			0.0001°
		1μF ± 1%	± 0.01μF
		1μF ± 2%	± 0.01μF
		1 ± 1%	± 0.01
7		1 ± 2%	± 0.01
		± 0.2° (1.0V
		± 0.3° (: 0.2V 1.0V)
8			30A
9			10KV
10			550 L × 430

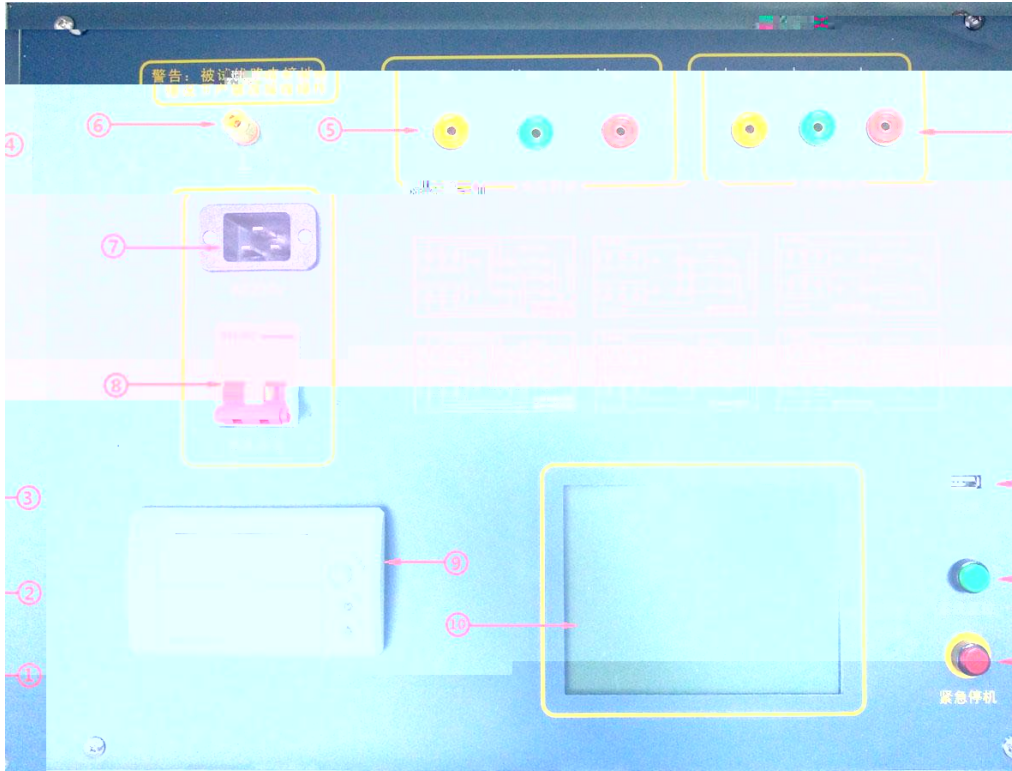

3.1

3-1- 1



3.2

3-1-2

3.3 USB

3-1-3

U

U

USB

U

U

U

3.4

A B C

3-1-4

A

B

C

3

3.5

UA UB UC

3-1-5

UA

UB

UC

3

3.6

3-1-6

3.7

AC220V

3-1-7



3
3.8

3-1-8

3.9

3-1-9

3.10

3-1-10

55mm



赫兹电力
HERTZ POWER

产品宗旨：技术领先，质量可靠，轻便易用
服务宗旨：快速响应，达到满意，超过期望



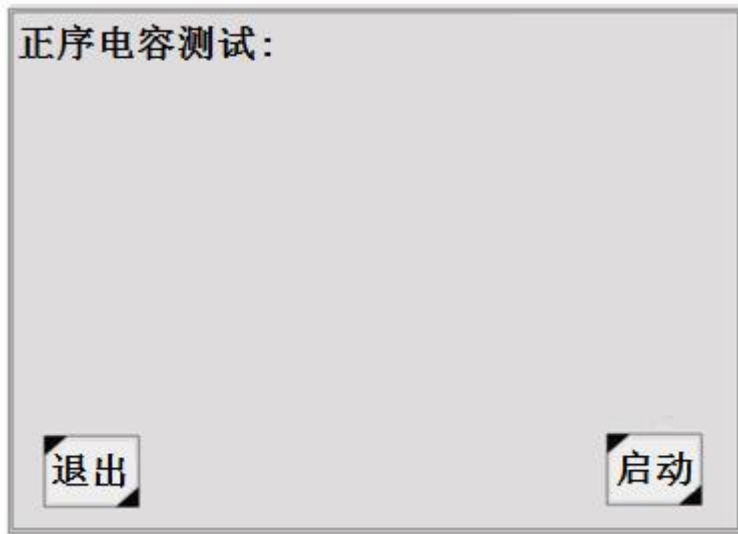

4—3

4

—4

10

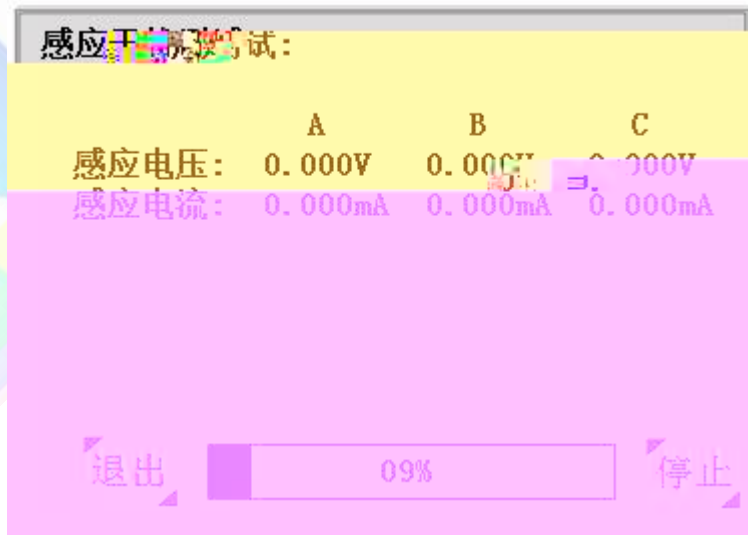

4—4

45Hz

200

4

200

4

45Hz

4—5

4—8

45Hz

55Hz

55Hz

4—6

4—9

225

027-83267669





测试日期/时间:2018-10-20/08:49:09

测试结果:

Z1: 896.6

V: 3.569

Z1 V :

R1 I :

X1 :

Y1 Km

G1

B1 :

C1 :

B

4-11

4

时间设置:

2018 - 10 - 20 08:18



保存

退出



时间	长度	项目
00 2018-10-20 10:28	10.0	Z0
01 2018-10-20 10:24	10.0	Z1
02 2018-10-20 10:19	10.0	Z1
03 2018-10-20 10:13	10.0	Z1
04 2018-10-20 10:06	10.0	C1
05 2018-10-20 09:59	10.0	C0
06 2018-10-20 09:52	10.0	Cm
07 2018-10-20 09:47	10.0	Zm
08 2018-10-20 09:41	10.0	C1
09 2018-10-20 09:33	10.0	C0



" " 4-12 " U "

U 4-14

—

"

"

2018-10-20 11:19

U盘数据管理

备 份： 113组

退 出

文件保存成功！

U

TXT

"

"

—



IA IB IC ()
UA UB UC ()

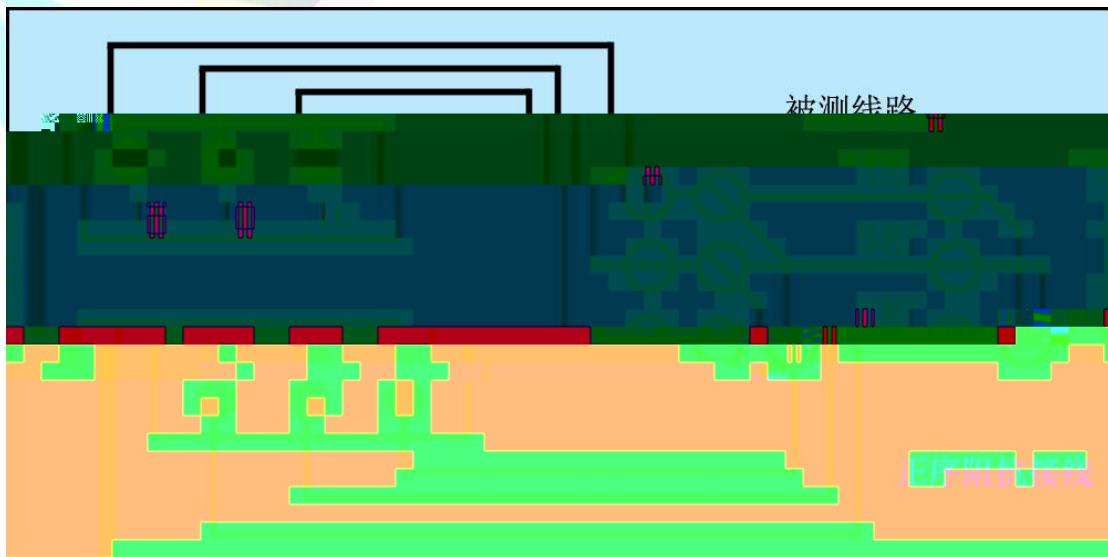

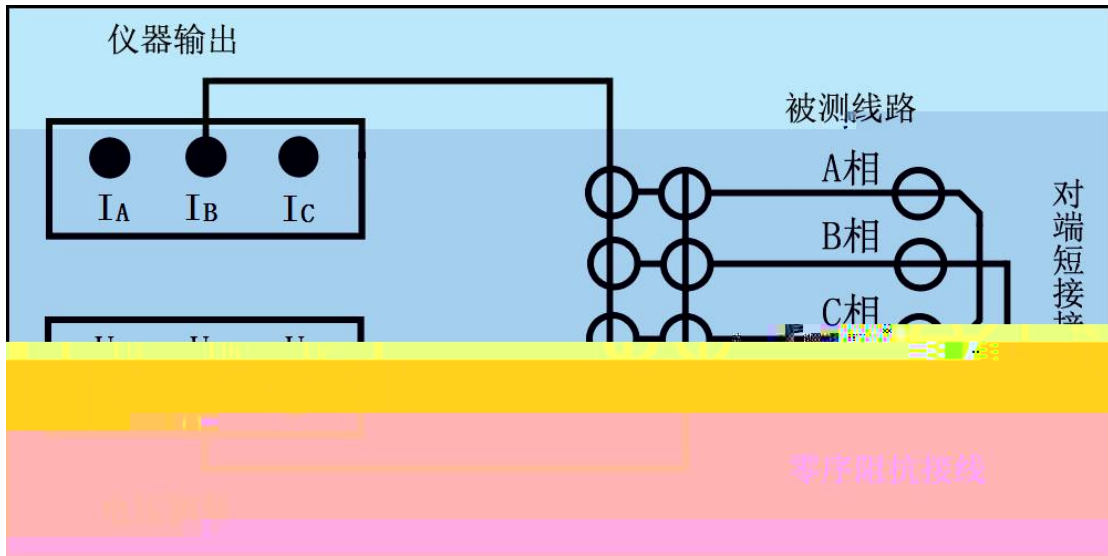

5.3

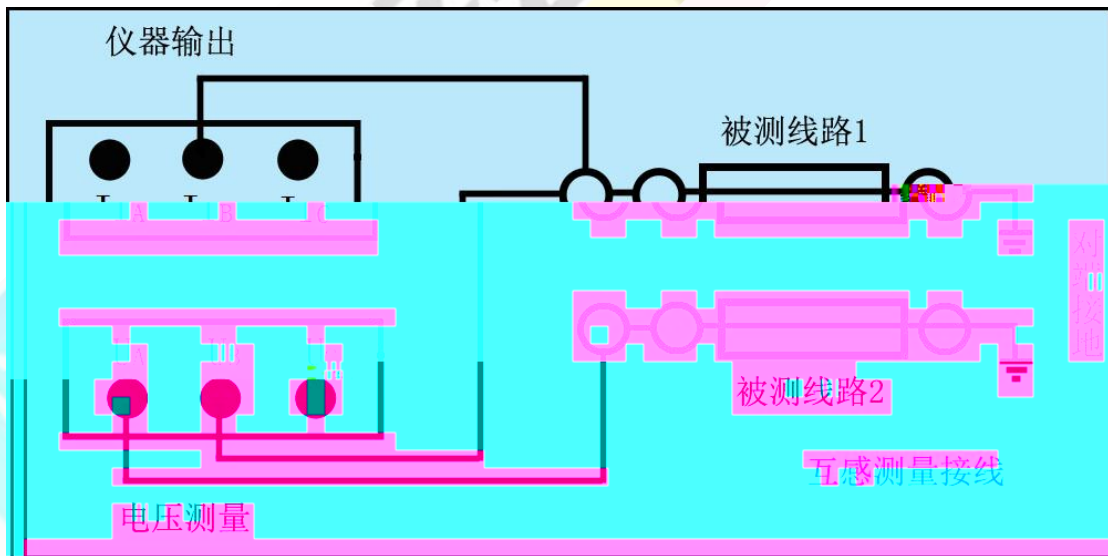

5—3

5.4

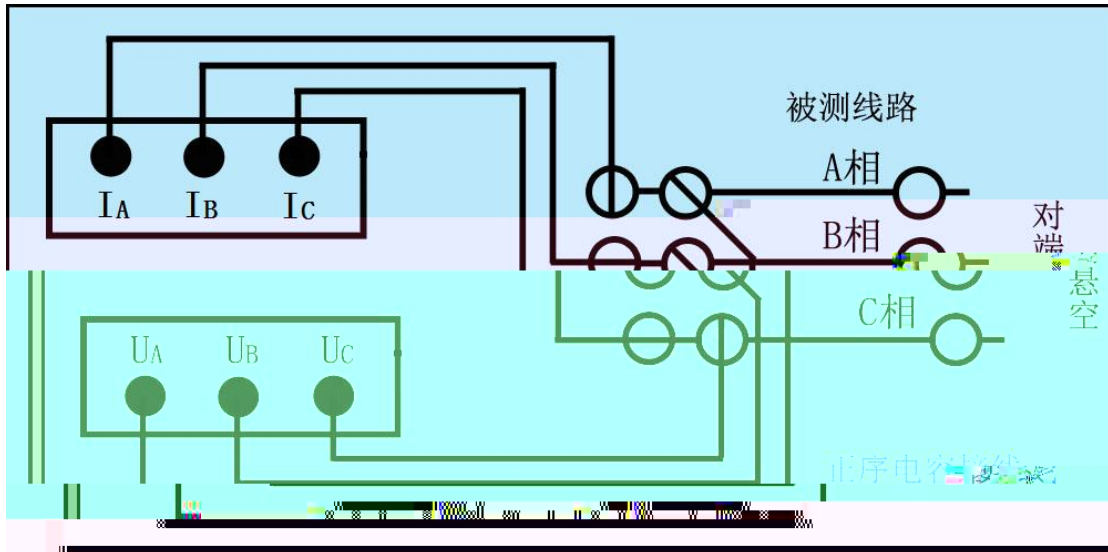

5—4

5.5

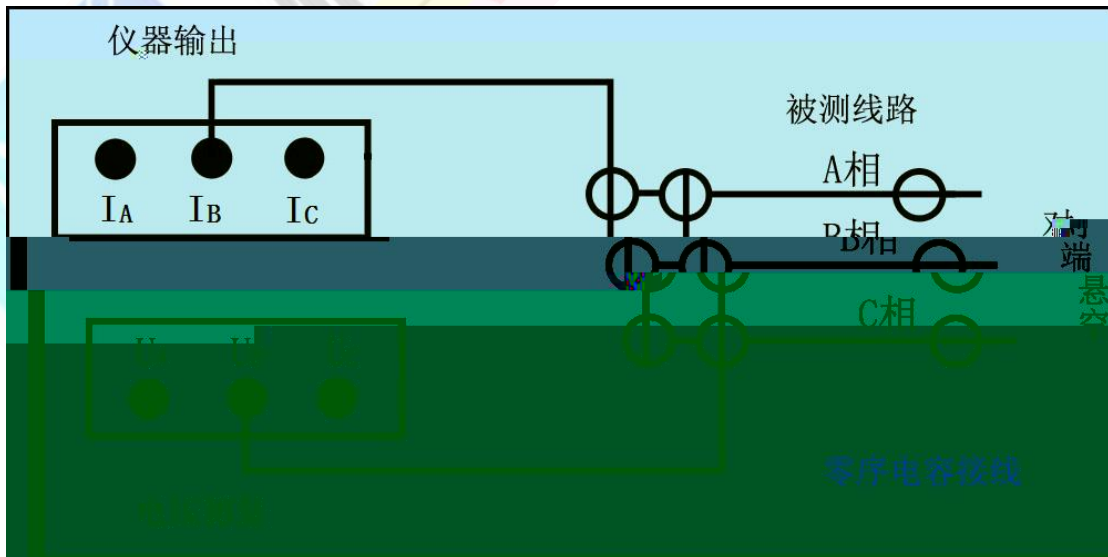

5—5

5.6

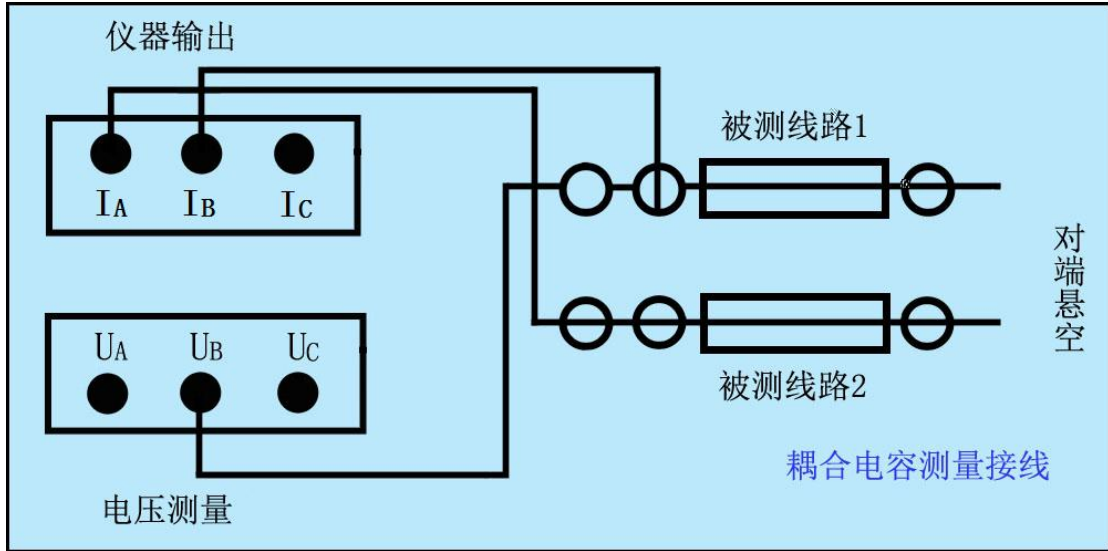

5—6



赫兹电力
HERTZ POWER

产品宗旨：技术领先，质量可靠，轻便易用
服务宗旨：快速响应，达到满意，超过期望

