

$$\frac{| \cdot A \cdot B \cdot |}{e}$$

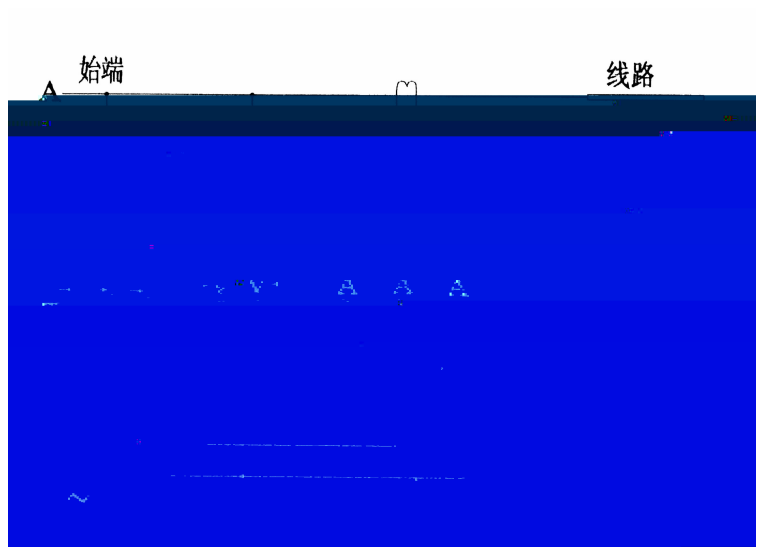

$$I \frac{I_A \ I_B \ I}{\quad}$$

$$\frac{AB \ B \ A}{\quad}$$

$$P \ P \ P$$

$$R \ \frac{P}{I}$$

$$\sqrt{I}$$

$$\sqrt{\quad} R$$



$$g \ \overline{R}$$

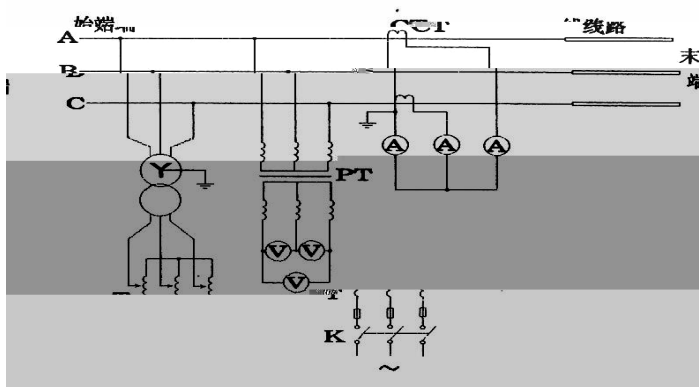

I

B

B

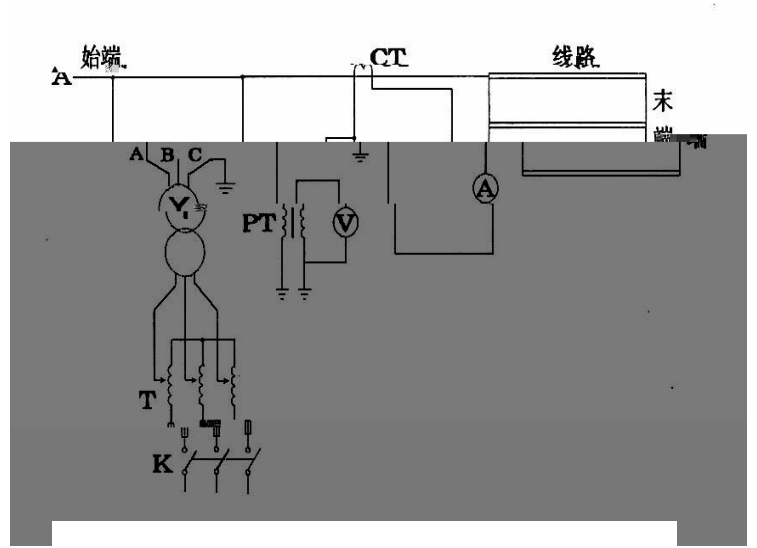

I

L

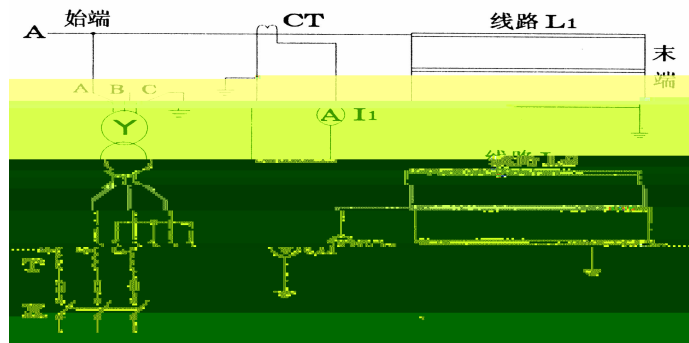

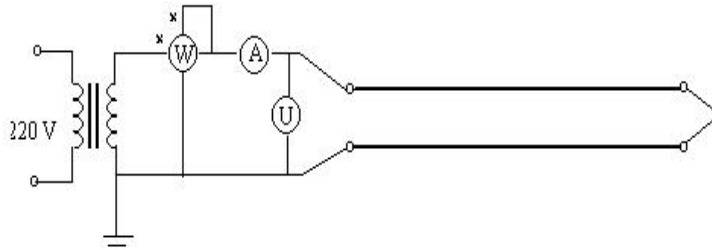

$$R = \frac{\overline{P}}{\overline{I}}$$

$$R = \sqrt{\frac{P}{I}}$$

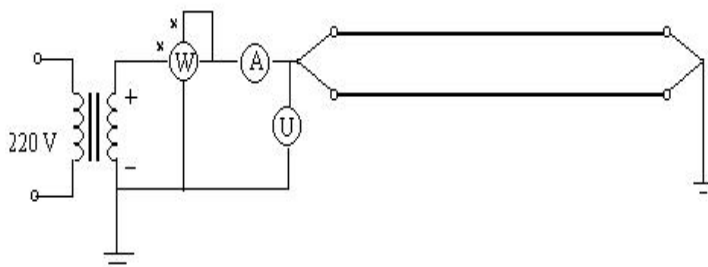

$$\frac{P}{I}$$

$$\frac{P}{I}$$

$$R = \frac{\sqrt{I}}{I}$$

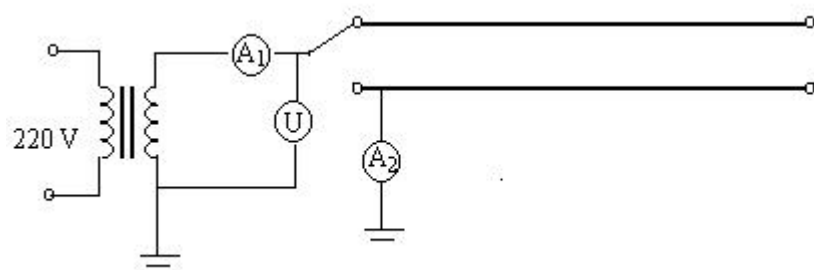

$$I \quad I \quad I$$

$$\frac{I}{H}$$

$$H \quad \frac{I}{H}$$

$$- \quad H$$

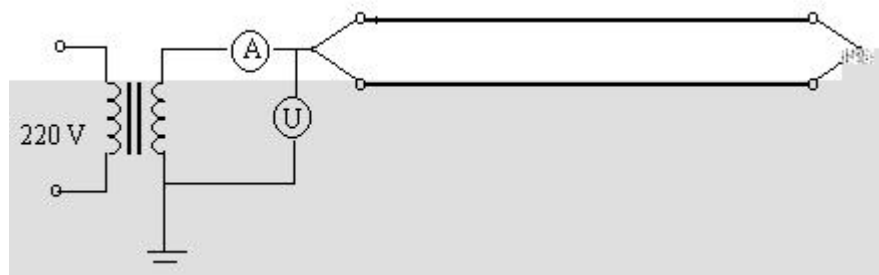

I

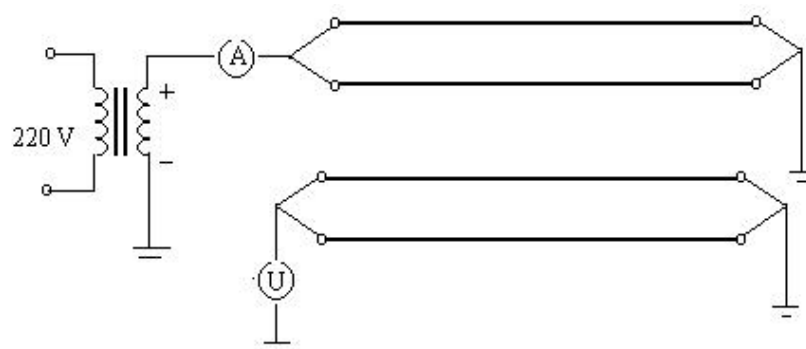

^H I

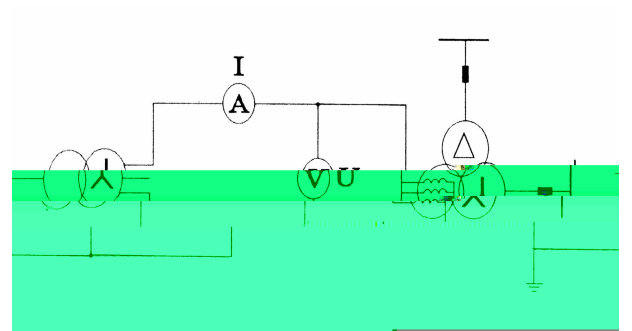

$$d \frac{1}{I} \sqrt{d d d}$$
$$d \sqrt{d d d}$$
$$\sqrt{d d d}$$

○

○

d

d